

Assembly Instructions

Essentials Bunk Bed

1/7

Safety Advice

Please take the time to carefully read through the whole of these instructions before you commence.

Keep these instructions for future reference.

Unpack, inspect and check off all of the contents.

Please dispose of all packaging safely.

Small component parts could choke a child if swallowed.

We strongly recommend that you keep children well away from the work area.

It would be sensible to lay a sheet or blanket on the floor where you intend to work to avoid scratching this product and to protect your floor.

This product is heavy. Take extreme care when lifting to avoid personal injury or damage to the product.

Assemble the product as close to its intended final position in the room as possible.

Please check the contents of boxes before attempting to assemble this product. A full checklist of parts and fittings is given in page 2 of this instruction leaflet.

HANDY HINT : If you keep the hardware in a bowl during assembly you will be less likely to lose them.

IMPORTANT-READ CAREFULLY-RETAIN FOR FUTURE REFERENCE

WARNING: High beds and the upper bed of bunks beds are not suitable for children under six years due to the risk of injury from falls

WARNING: Bunk beds and high beds can present a serious risk of injury from strangulation if not used correctly.

Never attach or hang items to any part of the bed that are not designed to be used with the bed, for example, but not limited to, ropes, strings, cords, hooks, belts and bags.

WARNING: Children can become trapped between the bed and the wall, a roof pitch, the ceiling, adjoining pieces of furniture (e.g. cupboards) and the like. To avoid risk of serious injury, the distance between the top safety barrier and the adjoining structure shall not exceed 75mm or shall be more than 230mm.

WARNING: Do not use the bunk bed/high bed if any structural part is broken or missing and always follow the manufacturer's instructions.

The largest size of mattress recommended for safe use is 190cm x 90cm with maximum thickness of (6 inch).

Frequent ventilation of the room is necessary to ensure that humidity is kept low and to prevent mould forming in and around the bed.

We strongly recommend regular checks on all assembly fastenings to ensure they are properly tightened.

This bunk complies with BS EN 747-1:2012+A1:2015

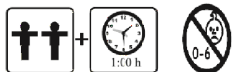
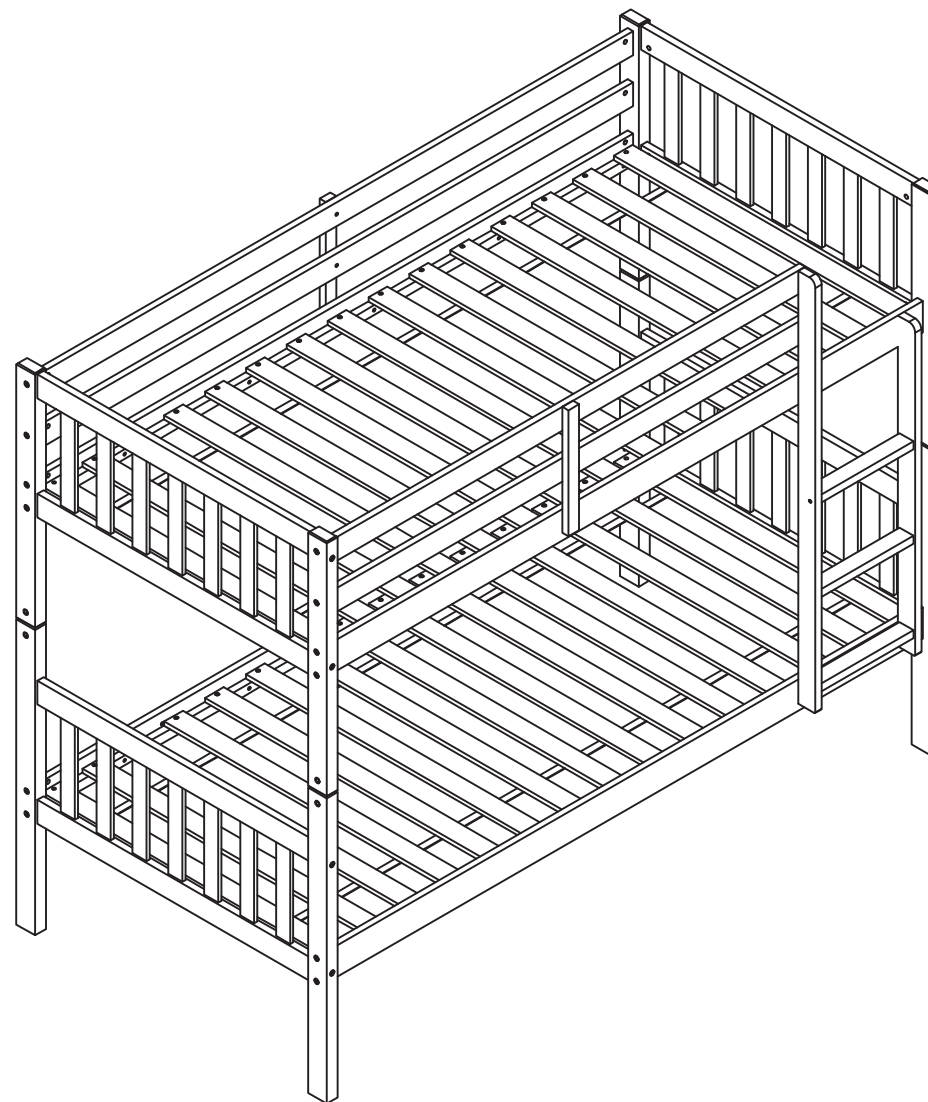

Assembly Instructions Essentials Bunk Bed

2/7

Part in Box 1

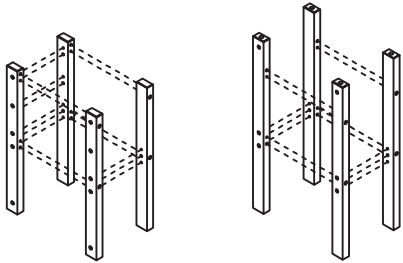

(A) Upper Post (Shorter) x 4
(B) Lower Post (Longer) x 4

Part in Box 2

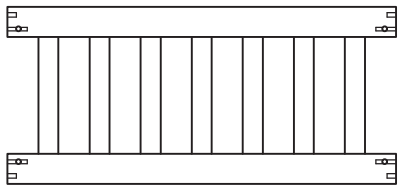

(C) Hb. Fb. Panel x 4

Part in Box 3

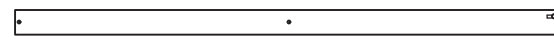

(D) Front Upper Guardrail x 2

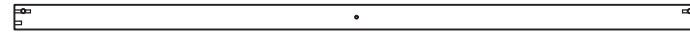

(E) Back Upper Guardrail x 2



(F) Guardrail Spindle x 2

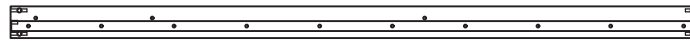

(G) Upper Side Rail (Front) x 1

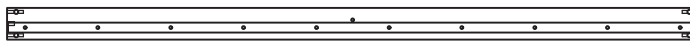

(H) Upper Side Rail (Back) x 1

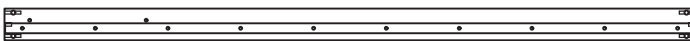

(I) Lower Side Rail (Front & Back) x 2



(J) Ladder Rail (Long) x 1



(K) Ladder Rail (Short) x 1

Part in Box 4

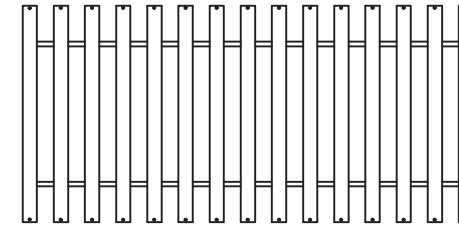

(M) Set of Slats x 2

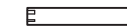

(L) Ladder Steps (x 3)

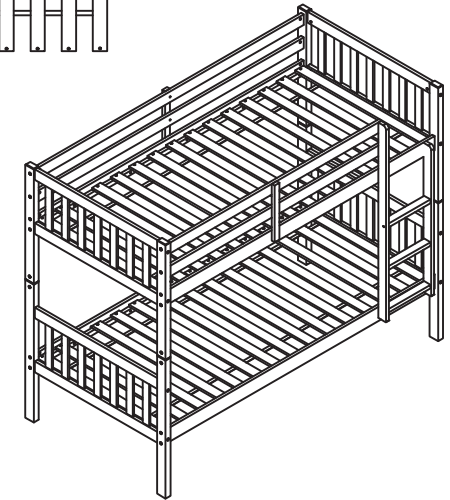

Hardware List

1.	JCBC M6 x 100mm		x 16
2.	M6 x 15mm Barrel Nut		x 38
3.	Wood Dowel M10 x 30mm		x 36
4.	JCBC M6 x 80mm		x 22
5.	JCBC M6 x 30mm		x 6
6.	Metal Pin M10 x 100mm		x 4

7.	JCBC M6 x 25mm		x 8
8.	JCBC-W M6 x 50mm		x 12
9.	JCBC-W M6 x 30mm		x 8
10.	CSK M4 x 25mm		x 52
11.	Wooden Button 11.5mm		x 4
12.	M4 Allen Key		x 1

Tool required for assembly :

- * Allen Key (supplied)
- * Phillis Screwdriver (not supplied)



WARNING !!



- To help prevent serious or fatal injuries from entrapment or falls :
- The top of the Mattress shall be at least 160mm below the upper edge of the safety barriers. The maximum thickness of the mattress shall be 6".
 - Only use mattress that is 1900mm (75") long and 900mm (35") wide on upper a shall be at least 160mm (6-1/4) below the edge of the safety barriers.
 - Follow written instructions with this bed.
- STRANGULATION HAZARD** — Never attach or hang item to any part of the bunk bed that are not designed for use with the bed; for example , but not limited to, hook, belt, and jump ropes.
- This upper bed is not suitable for children under six years.
 - EN 747 : 2012 + A1 : 2015
 - Made in Malaysia
 - Importer by Mattressman Ltd.

DO NOT REMOVE THIS LABEL

Assembly Instructions



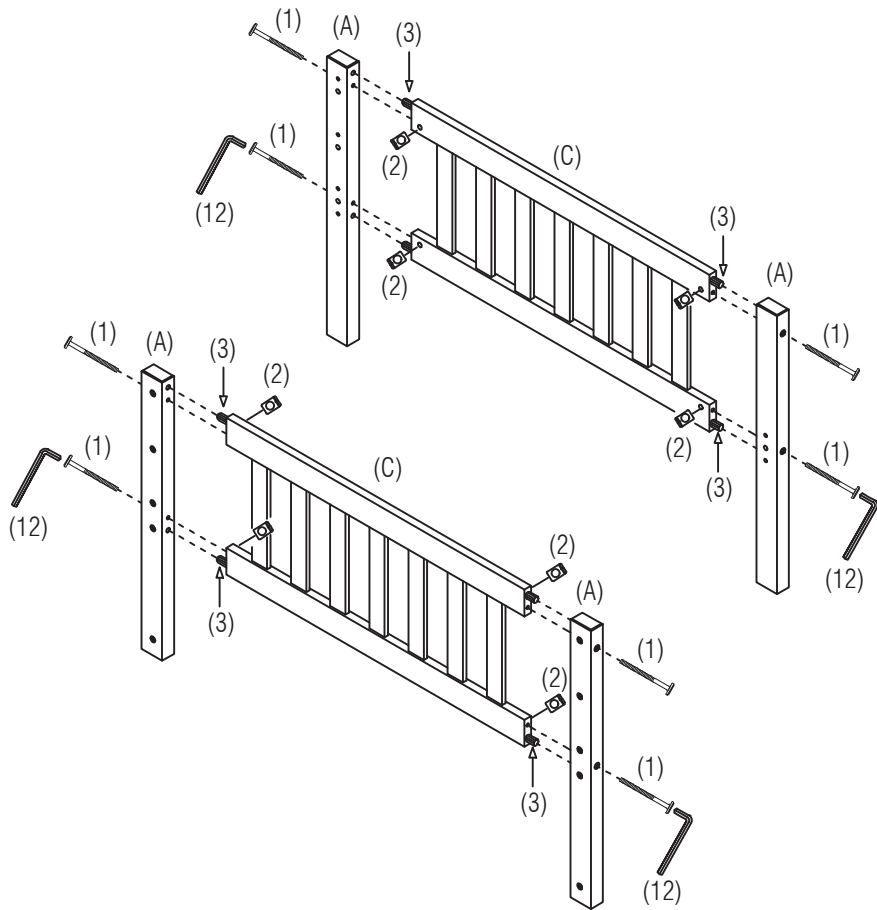

Essentials Bunk Bed

1 Assemble the Upper Bunk End Frames.

1.	JCBC M6 x 100mm		x 8
2.	M6 x 15mm Barrel Nut		x 8
3.	Wood Dowel M10 x 30mm		x 8



2 Assemble the Upper Bunk End Frames with the Side Rails (G&H), Front and Back Guard Rails (D&E). Attach the Guardrail Spindle (F).

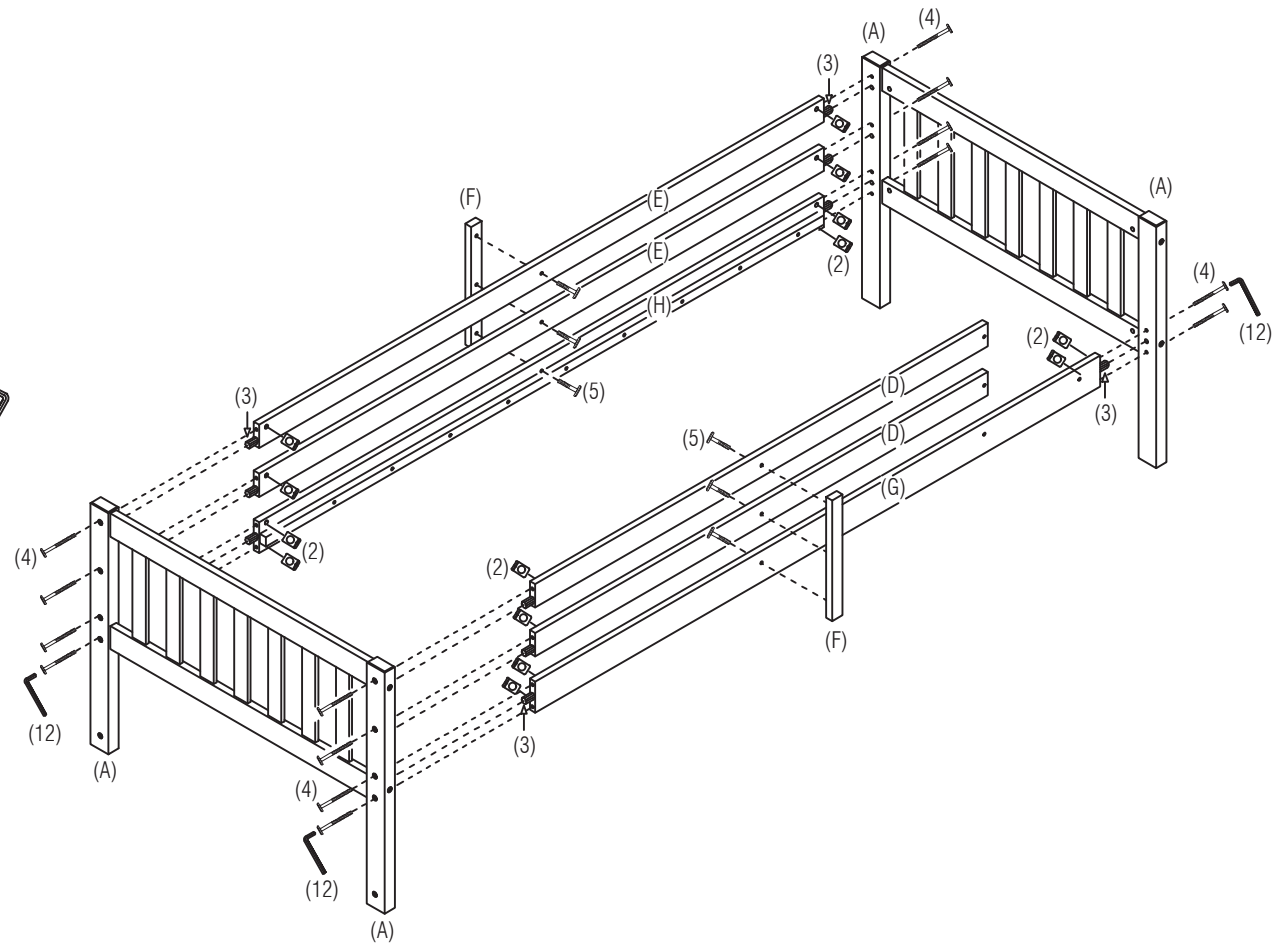

2.	M6 x 15mm Barrel Nut		x 14
3.	Wood Dowel M10 x 30mm		x 10
4.	JCBC M6 x 80mm		x 14
5.	JCBC M6 x 30mm		x 6



Assembly Instructions Essentials Bunk Bed



3

Assemble the Lower Bunk End Frames.

1.	JCBC M6 x 100mm		x 8
2.	M6 x 15mm Barrel Nut		x 8
3.	Wood Dowel M10 x 30mm		x 8

4

Assemble the Lower Bunk End Frames with the Side Rails (I&J).

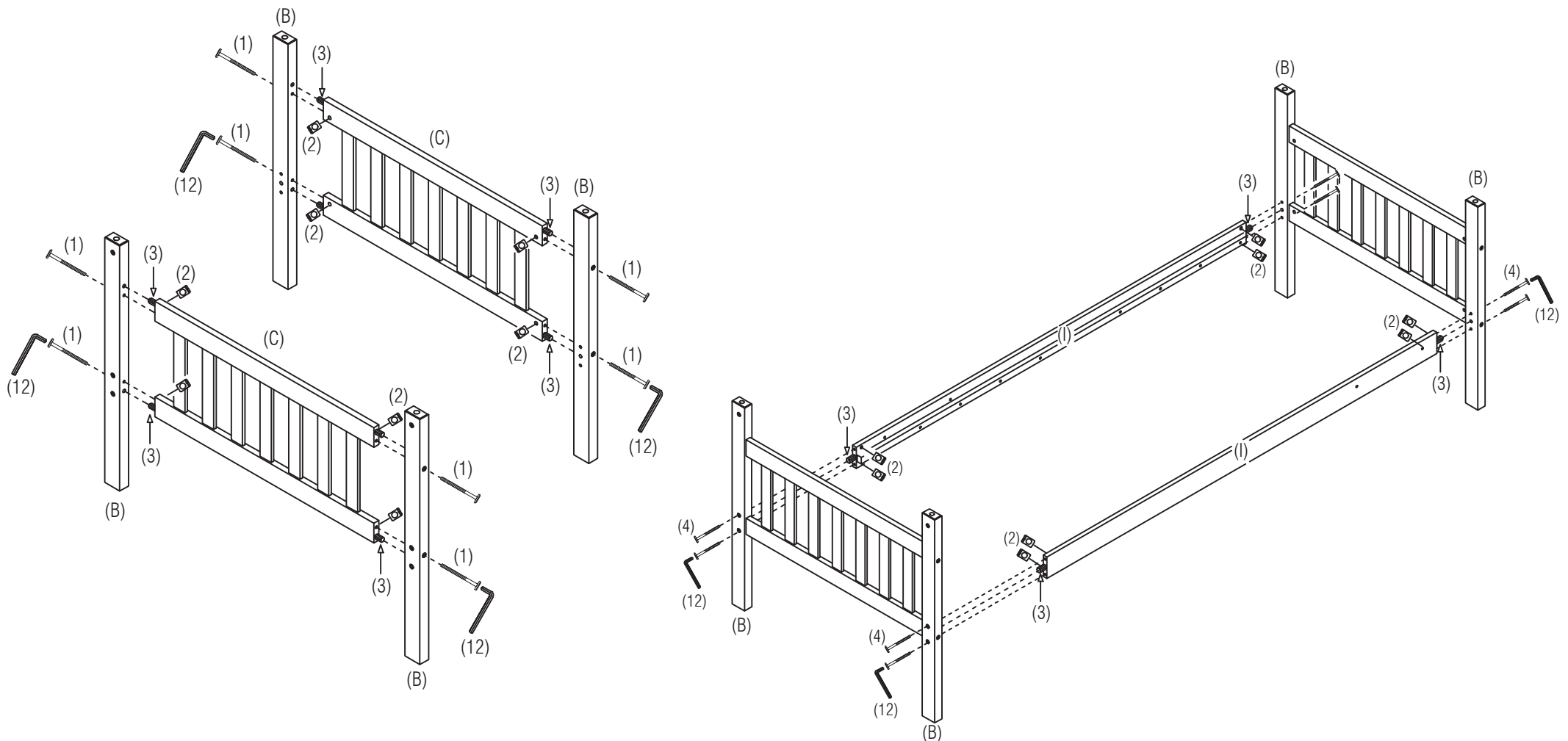

2.	M6 x 15mm Barrel Nut		x 8
3.	Wood Dowel M10 x 30mm		x 4
4.	JCBC M6 x 80mm		x 8



Assembly Instructions Essentials Bunk Bed

5

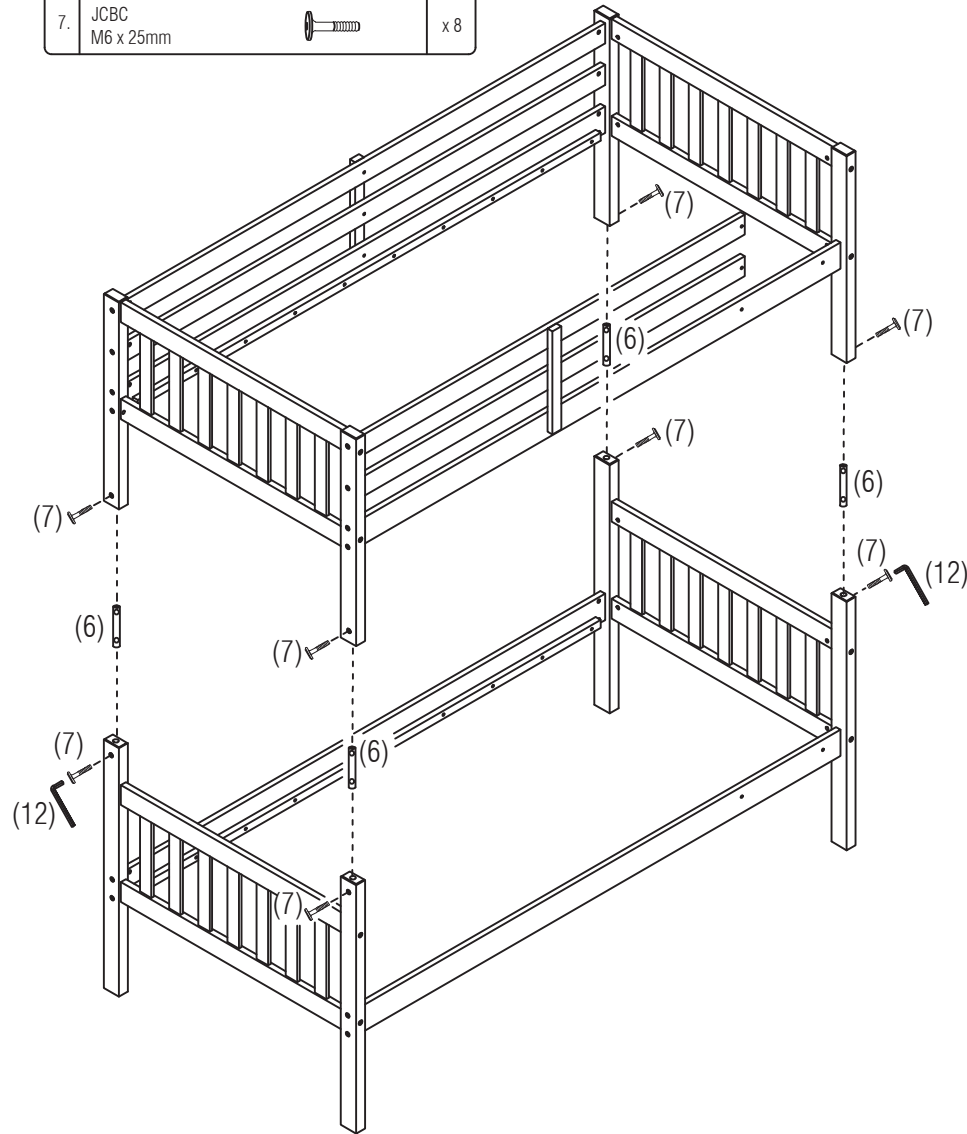

Join the Upper & Lower Bunk.

6.	Metal Pin M10 x 100mm		x 4
7.	JCBC M6 x 25mm		x 8



6

Assemble the Ladder (K,L&M).

3.	Wood Dowel M10 x 30mm		x 6
8.	JCBC-W M6 x 50mm		x 6

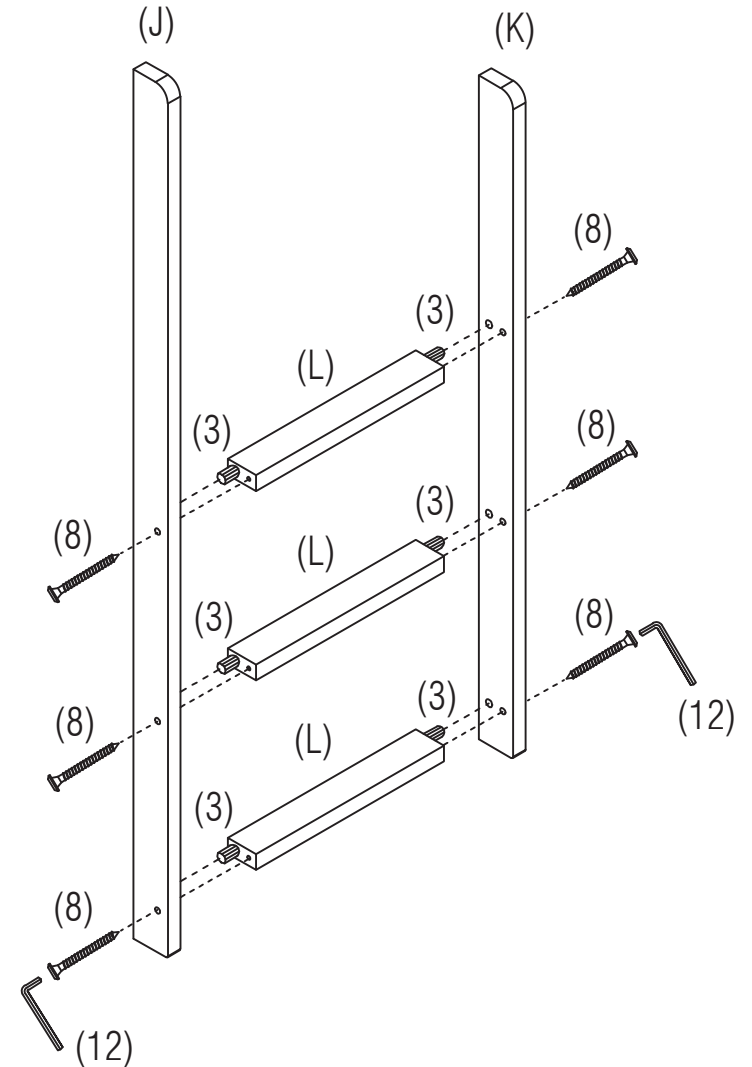

Assembly Instructions Essentials Bunk Bed

7

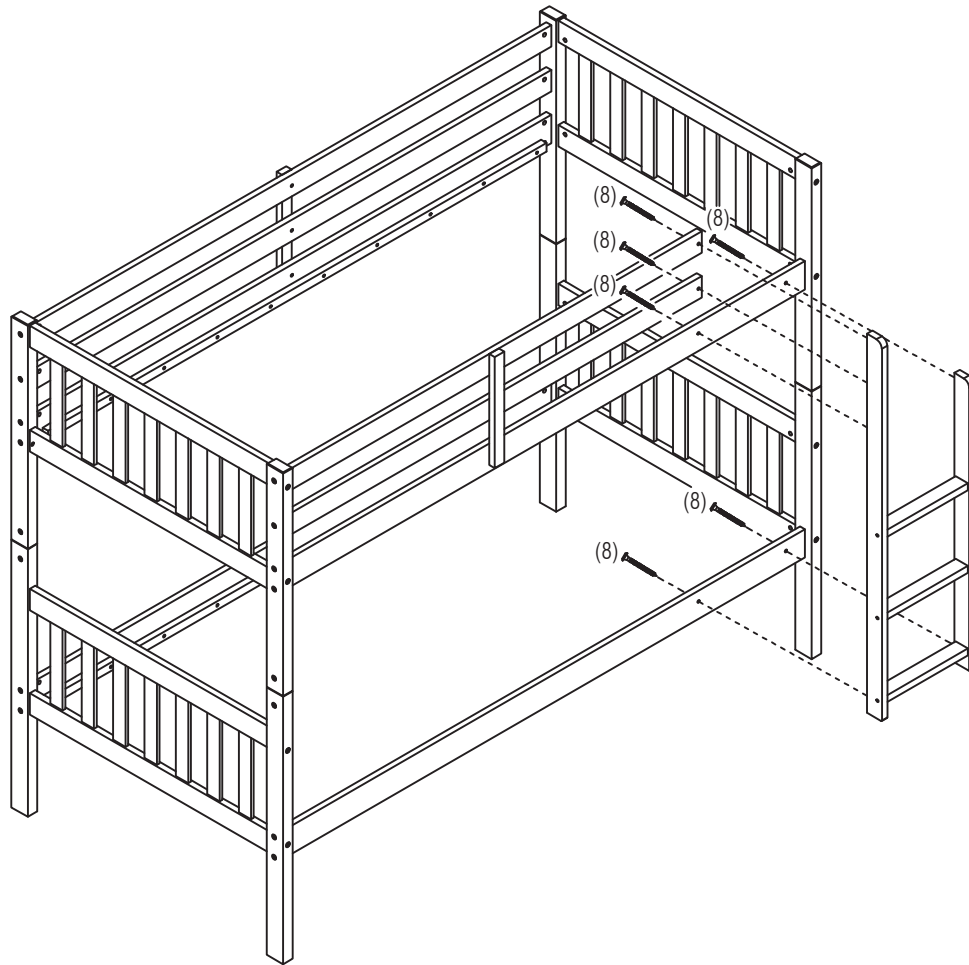

Attach the Ladder to Upper & Lower Bunk.

8.	JCBC-W M6 x 50mm		x 6
----	---------------------	---	-----



8

Assemble the Slats (M) to the Upper & Lower Bunk.

9.	JCBC-W M6 x 30mm		x 8
10.	CSK Screw M4 x 25mm		x 52

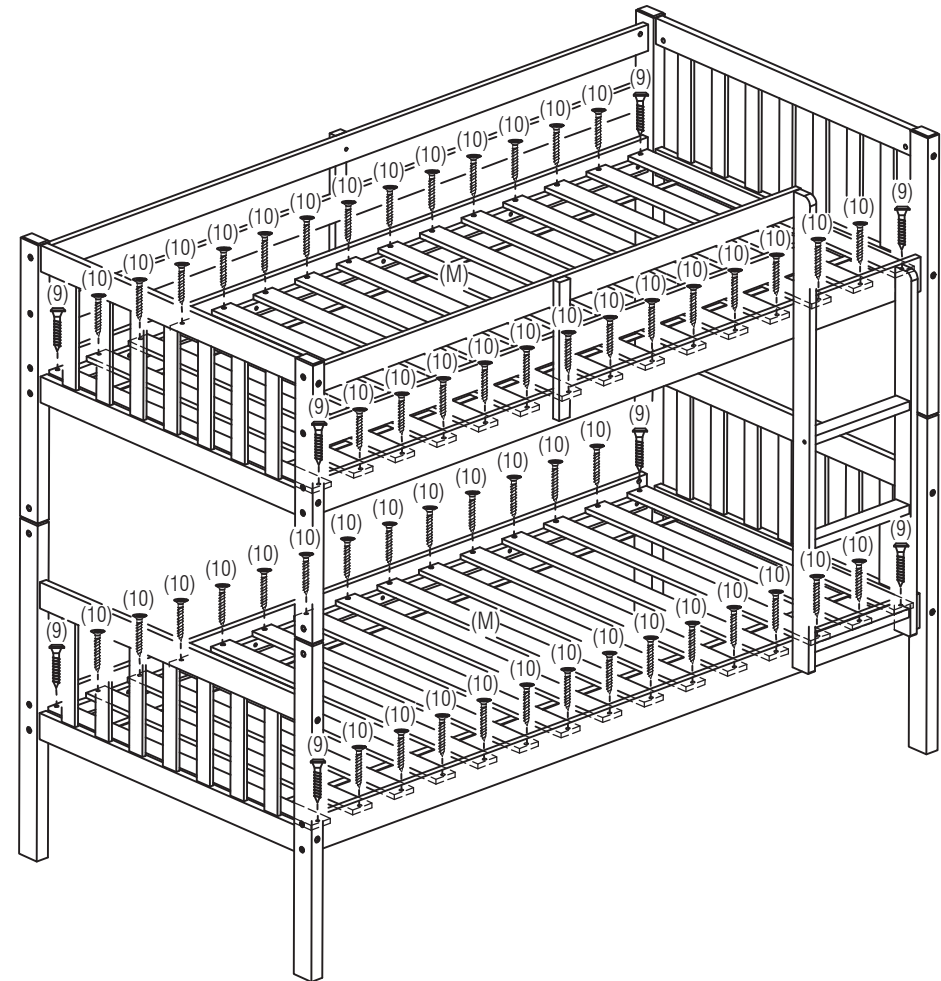

Assembly Instructions Essentials Bunk Bed

7/7

9

Optional use of bunk bed as separate Twin Beds.

11.	Wooden Button 11.5mm		x 4
-----	-------------------------	---	-----

